



# London

Benches and table for highly  
frequented areas



london ZL



london ML



## measurements

51 kg

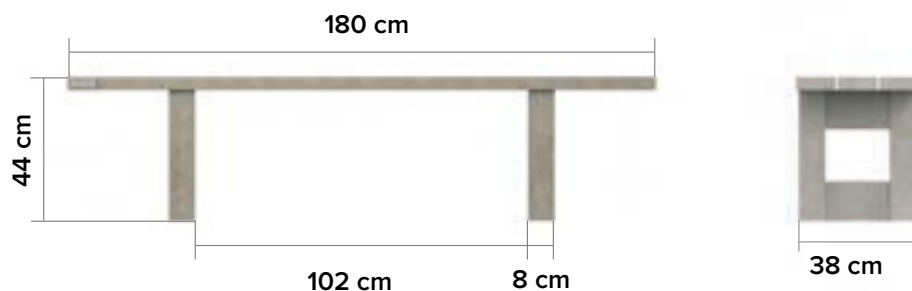

## available colours

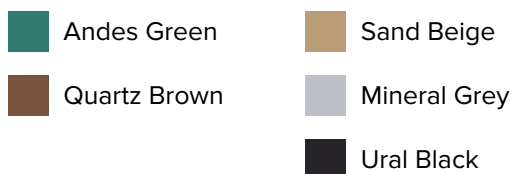

## bicolour options

### Boards

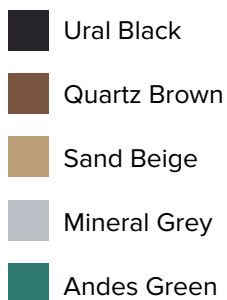

### Legs



## main advantages



100% plastic waste



Maintenance free



Rot-proof



Natural texture



Graffiti resistant



Splinter-free



Coloured throughout



Weatherproof



Completely recyclable

## measurements

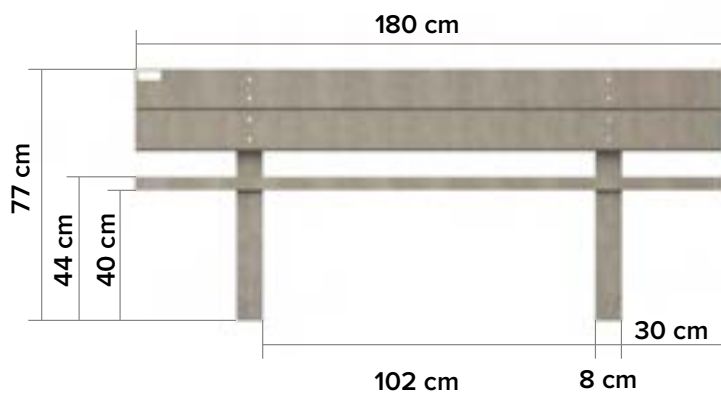

51 kg  
with rest: 87 kg



## available colours

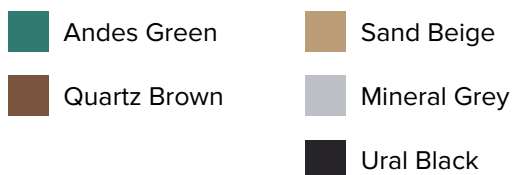

## bicolour options

### Boards

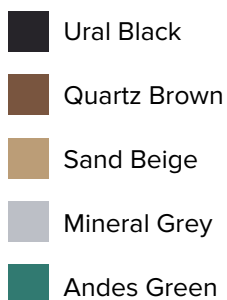

### Legs



## main advantages



100% plastic waste



Maintenance free



Rot-proof



Natural texture



Graffiti resistant



Splinter-free



Coloured throughout



Weatherproof



Completely recyclable

anchoring

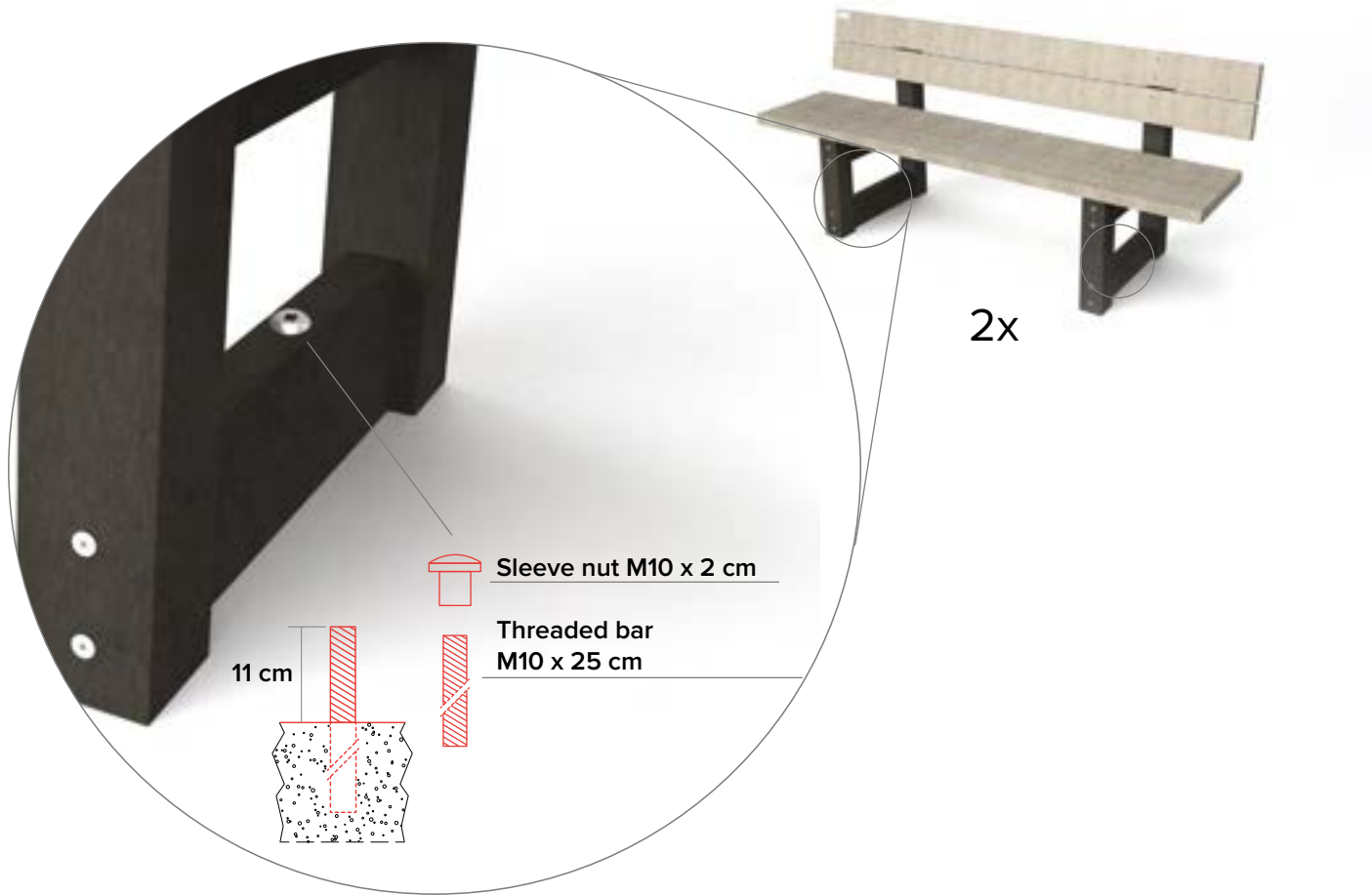

reinforcement



nice in combination with

